

GLOBALCRUISE
ELECTRIC CRUISE CONTROL

UNIVERSAL APPLICATION
INSTALLATION & OWNER'S MANUAL

CONTENTS

SAFETY PROCEDURES	2
HELPFUL HINTS.....	4
PARTS LIST.....	5
PARTS DIAGRAM.....	6
SUPPLEMENTAL PARTS.....	7
SWITCH SETTINGS.....	8
INSTALLATION	9
TROUBLESHOOTING.....	20
WARRANTY.....	23
OPERATING INSTRUCTIONS	24

SAFETY PROCEDURES

The **GlobalCruise** is a microprocessor based Cruise Control. It is designed for ease of installation and can be used with most cars, light trucks and vans. Carefully follow the installation procedures in this manual for best results.

DO NOT INSTALL THIS SYSTEM ON A DIESEL POWERED VEHICLE WHICH HAS A MANUAL TRANSMISSION WITHOUT A DISENGAGEMENT SWITCH (Kit# 250-4206) ON THE CLUTCH PEDAL ASSEMBLY.

Your vehicle must have a **VSS** (*Vehicle Speed Signal*) wire or an available signal generator for installation of the **GlobalCruise**. Please consult vendor's application guide.

Throughout the instructions there are **WARNINGS, CAUTIONS, AND NOTES** that are meant to make it easier for you to install the **GlobalCruise** on your vehicle and make it safer to use. We have gathered these tips from people across the country who have informed us of their problems and solutions. Even with all these reports from the field, we cannot cover every condition which you might encounter, there are just too many different vehicle makes and models. We do our best to tell you how to handle most vehicles, but we must **Depend on Your Good Judgement** for dealing with the rest.

Therefore, we believe you can understand why we **strongly** urge you to think carefully about what could happen to you, your passengers, and your vehicle if you use any tools, parts, fastening methods, routing or procedures which are not described in this manual.

There is **NO** drain on the battery if the control switch is left on. The **GlobalCruise** needs no regular service.

WARNING

Failure to follow the instruction manual could not only cause the GlobalCruise to work improperly, but could cause the throttle to hang up, possibly causing damage to your vehicle and injury and/or death to you and your passengers.

WARNING

If you question the applications of the GlobalCruise, please consult the applicable application guide. Only install on approved applications.

The product described in this manual was developed, manufactured and tested in line with recognized technical standards and is in compliance with the fundamental safety requirements.

Nevertheless, there are residual risks! It is therefore important to read this manual before installing and connecting the product. Keep the manual in a place that is readily accessible at all times.

Throttle Adaptor

In order to cover certain vehicles with a universal cruise control, we have designed throttle adaptors for performance and safety. Consult current Application Guides and Vehicle Technical Information Guides to see if your vehicle needs a Throttle Adaptor before you install the **GlobalCruise**. If an adaptor is listed, it must be used with that application.

Target Group and Qualified Installation

This description is intended for those persons who install the product in the motor vehicle. In order to be able to operate properly, the **GlobalCruise** must be correctly installed. The system may therefore be installed and wired by persons who know and have understood the installation instructions of this manual and are familiar with automotive electrical and mechanical systems. Installation by nonqualified personnel can lead to injury to the driver or third parties, or damage to property or the environment.

Modifications to the product

The **GlobalCruise** is designed, manufactured and tested with due regard to safety and reliability.

Modifying or tampering with the product can affect its safety. This can lead to death, serious or slight injury to the driver or third parties, or damage to property or the environment. For this reason, the product must not be modified or tampered with!

Inform the user

Hand the Operating Manual for the cruise to the user. The Operation Manual is an integral part of the product!

If the cruise has not been fitted with a clutch switch, Please inform the user that the engine speed briefly increases when the function is switched off via the clutch.

WARNING

The information in this manual has been carefully compiled through actual vehicle testing and manufacturers service manual research and to the best of our ability is accurate. However, we do not warrant the accuracy of this information against changes in vehicle design, the use or misuse of this information or typographical errors. It is the responsibility of the installer to verify the signal and color on the wire attachments prior to and after the installation of the **GlobalCruise** to assure proper operation. We do not accept any responsibility for damage to the vehicle or injury to its occupants caused by the use of this information. Improper installation and/or connection to the incorrect wires could cause **GlobalCruise** or vehicle malfunction, component damage, and or personal injury for you and/or your passengers.

HELPFUL HINTS

1. BEFORE STARTING INSTALLATION:

Familiarize yourself with the Installation Instructions and **GlobalCruise** components.

2. MATING CONNECTORS:

A. When disconnecting, hold connector and press the lock downward while pulling connectors apart. **Figure A**

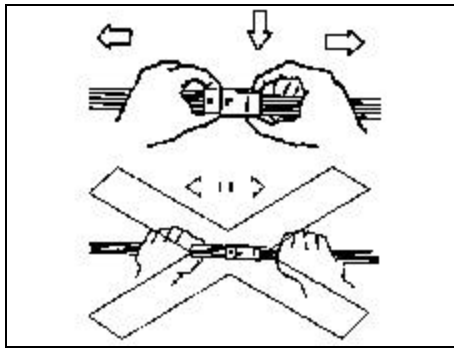

Figure A

CAUTION
Do not pull on wires.

B. When inserting, push mating connectors together until locking mechanisms are firmly locked together. **Figure B**

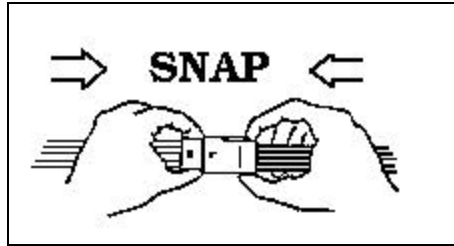

Figure B

3. AIRBAG AND ANTI-THEFT RADIO:

A. If vehicle is equipped with an Anti-Theft Radio, the radio code must be written down prior to disconnecting battery cable. The code must be reentered when the negative battery cable is reinstalled.

B. If vehicle is equipped with an airbag (SRS), it is advisable to disconnect the negative battery cable. However, remember that some vehicles retain power to the airbag system when battery is disconnected.

4. REMOVAL OF NEGATIVE BATTERY CABLE:

Disconnect the negative battery cable before installing the **GlobalCruise** for safety precautions. Remember to reconnect the cable after installation. **Figure C**

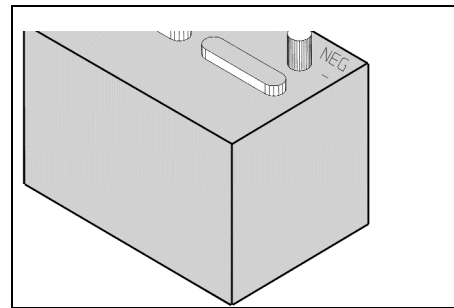

Figure C

5. ACCESSORY POWER:

When installing the special terminal into the fuse panel of vehicle, See **Figure D**.

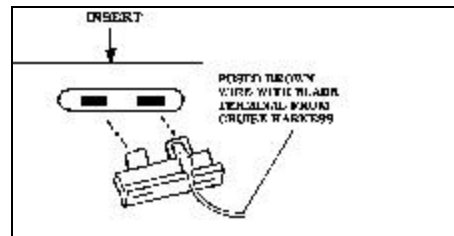

Figure D

WARNING

Failure to follow the instruction manual could not only cause the **GlobalCruise** to work improperly, but could cause the throttle to hang up, possibly causing damage to your vehicle and injury and/or death to you and your passengers.

HELPFUL HINTS

<u>ITEM</u>	<u>SERVICE PART #</u>	<u>DESCRIPTION</u>	<u>QTY</u>
A	250-2316	CRUISE MODULE	1
B	250-2317	CRUISE HARNESS	1
C	250-3607	CRUISE CABLE	1
D	250-2236	MODULE BRACKET	1
E	250-3700	CABLE BRACKET	1
F	250-3425	CONVOLUTED TUBING (58")	1
	250-2214	HARDWARE PACKAGE (UNIVERSAL)	
	250-2232	HARDWARE PACKAGE (-G, GM KIT)	
		G1 MODULE BOLT	2
*	*	G2 SELF-THREADING BOLT (M6 x 19)	4,2
*	*	G3 BEAD CHAIN	1
*	*	G4 BEAD CHAIN CONNECTOR	2
*	*	G5 CONNECTOR COVER	2
*	*	G6 LOOP CABLE (67MM)	1
*	*	G7 THREE BEAD CONNECTOR	1
*	*	G8 EYELET CONNECTOR	1
*	*	G9 TIE STRAP (102MM)	1
*	*	G10 TIE STRAP (190MM)	10
*	*	G11 TUBE CLAMP (10MM)	1
*	*	G12 FLAG NUT (THREADED TUBE CLAMP)	1
		G13 M5 NUT	2
*	*	G14 GM HATCLIP	1
*	*	G15 LOCKWASHER NUT (#10-32)	2
		G16 COTTER PIN (2MM x 16MM)	1
*	*	G17 SNAP-IN ADAPTOR	1
*	*	G18 PUTTY SEALING	1
		G19 ADAPTOR THROTTLE CLIP W/CABLE	1
*	*	G20 CONN, SELF-STRIP (16-22 AWG)	2
*	*	G21 CONN, SELF-STRIP (16-18 AWG)	2
*	*	G22 SCREW, ROUND HEAD (#10-32 x .5)	2

Use **CLUTCH DISENGAGEMENT SWITCH (Kit# 250-4206)** for manual transmission vehicle when the **Dark Blue TACH** wire cannot be obtained from vehicle or fails to disengage the **GlobalCruise**.

Service Parts are available to replace any part in this kit (See **Service Part Numbers** above). **Additional Hardware** is available on **Page 7**

PARTS DIAGRAM

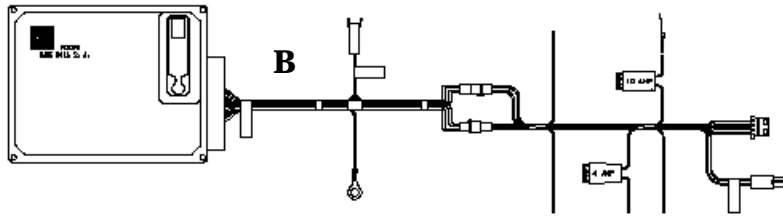

A

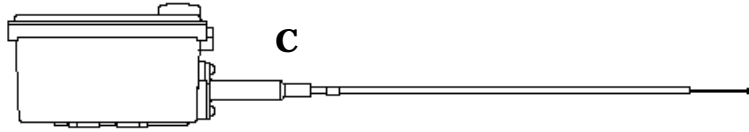

C

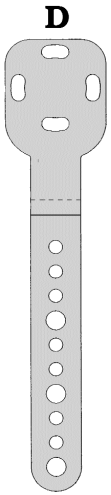

D

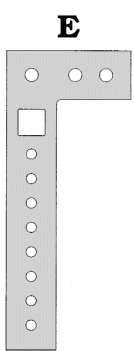

E



G1

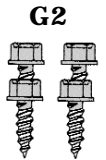

G2

G11 G12

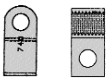

G14



F

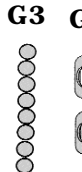

G3

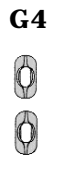

G4



G5



G6



G7



G8

G9

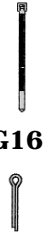

G10

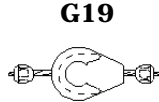

G19

G20



G21



G22



G13



G15



G16



G17



G18

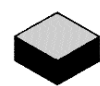





WARNING

Failure to follow the instruction manual could not only cause the **GlobalCruise** to work improperly, but could cause the throttle to hang up, possibly causing damage to your vehicle And injury and/or death to you and your passengers.

SUPPLEMENTAL PARTS

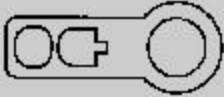
The following parts are available for your convenience and may simplify the installation of your **GlobalCruise**. Contact your local dealer or **ROSTRA** representative for details.

<u>ITEM</u>	<u>SERVICE PART #</u>	<u>DESCRIPTION</u>	<u>QTY</u>	
H. LOOP CABLES				H
1	250-2248	1.83" (47MM)	10	
2	250-3089	2.62" (67MM)	10	
3	250-2250	2.91" (74MM)	10	
4	250-2249	3.20" (81MM)	10	
5	250-2251	3.81" (97MM)	10	
J. T-BAR ADAPTORS				J
1	250-2252	1.65" (42MM)	10	
2	250-2247	2.74" (70MM)	10	
3	250-2253	3.03" (77MM)	10	
4	250-2254	3.53" (90MM)	10	
5	250-4248	5.93" (151MM)	10	
K. STUD-CLIP W CABLE				K
1	250-2261	1.00" (25MM)	10	
2	250-4255B	1.25" (32MM)	10	
3	250-4242	2.40" (61MM)	10	
4	250-2260	2.80" (71MM)	10	
L. THROTTLE COUPLERS*				L
1	250-4291	M6	10	
2	250-4292	M8	10	
M. TUBE CLAMPS				M
1	250-2255	3/16" (5MM)	10	
2	250-2256	1/4" (6MM)	10	
3	250-2257	5/16" (8MM)	10	
4	250-2258	3/8" (10MM)	10	
5	250-2259	1/2" (13MM)	10	
MISCELLANEOUS				N
N.	250-3440	GM™ HATCLIP	10	
P.	250-2262	PEDAL BRACKET ASSEMBLY**	1	

* The **THROTTLE COUPLER** Sets (**250-4291** and **250-4292**) come complete with **THROTTLE COUPLER**, **STUD CAP** and **ELASTOMER RETAINER**.

** The **PEDAL BRACKET ASSEMBLY (250-2262)** comes complete with a **PEDAL BRACKET**, a **SELF-LOCKING PIN**, an **M5-.8 x 12 BOLT**, an **M5 NUT** and two (**2**) **PLAIN WASHERS**.

SWITCH SETTINGS

The **CRUISE MODULE** must be programmed for the vehicle on which it is installed. The **twelve (12)** programming switches must be set according to the chart below in order for the **GlobalCruise** to operate properly. **Figure 1**

NOTE 1: Both the **VSS (Gray)** and **TACH (Dark Blue)** wires must be connected. (If the **Gray** wire is not used, an auxiliary road speed source must be used.) See **Page 18**.

NOTE 2: If using an "Open Circuit" control switch with the **GlobalCruise**, Switch number **twelve (12)** will have to be **OFF**. If you are unsure as to whether the control switch is "Open Circuit" or "Closed Circuit", look at the label of the packaging in which the switch came, or See **Page 22**.

NOTE 3: If any of the **twelve (12)** switches need to be changed after installation of the **GlobalCruise**, the control switch and the vehicle ignition must be in the **OFF** position; this is to allow the **GlobalCruise** to **RESET**.

The **twelve (12)** programming switches are located under the **Black Rubber Grommet** on top of the **CRUISE MODULE**.

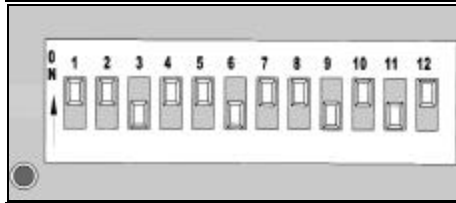

Figure 1 represents the **twelve (12)** programming switches for a vehicle characterized by:

- Switch **(1 & 2)** High Gain,
- Switch **(3 thru 6)** **18000 PPM**,
- Switch **(7 thru 9)** **6 Cylinder/Extra High** SetUp Timer,
- Switch **(10)** Square Wave Input,
- Switch **(11)** Manual Transmission, and
- Switch **(12)** Closed Circuit Control Switch

Programming Functions	1	2	3	4	5	6	7	8	9	10	11	12
Gain (Sensitivity)												
Extra Low	OFF	OFF										
Low	ON	OFF										
Mid	OFF	ON										
High	ON	ON										
Pulses/Mile (Pulses/Kilometer) see Page 18												
2000 (1250)			OFF	OFF	OFF	OFF						
4000 (2500)			ON	OFF	OFF	OFF						
6000 (3700)			OFF	ON	OFF	OFF						
8000 (5000)			ON	ON	OFF	OFF						
10000 (6200)			OFF	OFF	ON	OFF						
12000 (7500)			ON	OFF	ON	OFF						
18000 (11200)			OFF	ON	ON	OFF						
24000 (15000)			ON	ON	ON	OFF						
3200 (2000)			OFF	OFF	OFF	ON						
6400 (4000)			ON	OFF	OFF	ON						
9650 (6000)			OFF	ON	OFF	ON						
12870 (8000)			ON	ON	OFF	ON						
16090 (10000)			OFF	OFF	ON	ON						
19300 (12000)			ON	OFF	ON	ON						
28960 (18000)			OFF	ON	ON	ON						
38600 (24000)			ON	ON	ON	ON						
Engine/SetUp Timer												
8 Cylinder/Low							OFF	OFF	OFF			
4 Cylinder/Low							ON	OFF	OFF			
6 Cylinder/Low							OFF	ON	OFF			
6 Cylinder/Extra High							ON	ON	OFF			
8 Cylinder/High							OFF	OFF	ON			
4 Cylinder/High							ON	OFF	ON			
6 Cylinder/High							OFF	ON	ON			
4 Cylinder/Extra High							ON	ON	ON			
VSS Source see Page 18												
Sine Wave Input**										OFF		
Square Wave Input*										ON		
Transmission												
Manual											OFF	
Automatic											ON	
Control Switch see Page 22												
Open Circuit												OFF
Closed Circuit												ON

* VEHICLE'S COMPUTER

** AUXILIARY **VSS** SOURCE (SIGNAL GENERATOR, MAGNET KIT)

INSTALLATION

I. CRUISE MODULE MOUNTING

NOTE

DO NOT MOUNT THE CRUISE MODULE IN THE FOLLOWING AREAS:

- * Under the fender.
- * Under the vehicle.
- * Directly to the engine.
- * With the cable pointed down.
- * Near sharp, hot or moving objects.
- * Near ignition coil [No closer than 255mm (10")].
- * In the passenger compartment (Noise).
- * Where it will interfere with service checks.

A. Select a possible location to mount your **CRUISE MODULE**, set the **CRUISE MODULE** unmounted in that area. The reason for leaving the **CRUISE MODULE** unmounted is to make sure the **CRUISE HARNESS** will reach the passenger compartment and the **CRUISE CABLE** will reach the throttle attaching point.

B. Once you have selected a location, install the **MODULE BRACKET** to the bottom of the **CRUISE MODULE** with the **two (2) MODULE BOLTS** provided. It may be necessary to cut and bend the **MODULE BRACKET** to achieve a custom fit. **Figure 2**

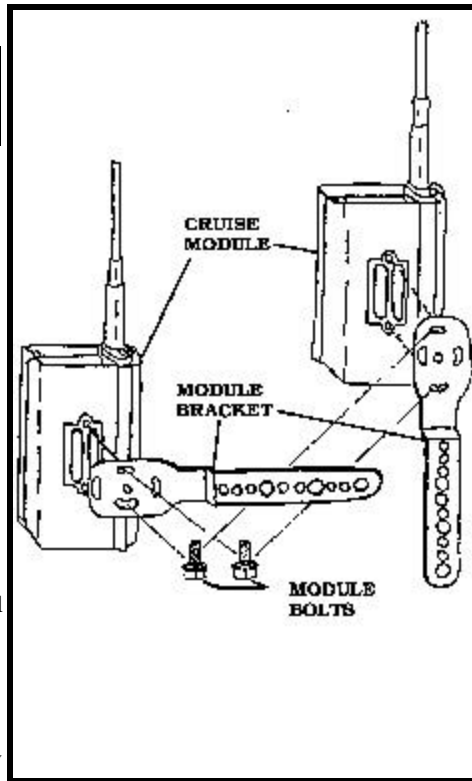

NOTE

DO NOT OVERTIGHTEN! DAMAGE TO THE CRUISE MODULE WILL OCCUR IF THE BOLTS ARE OVERTIGHTENED.

C. Mount the **CRUISE MODULE** in the spot you have selected using **two (2)** of the **SELF-THREADING BOLTS** provided in the kit. Be sure to set the programming switches located underneath the rubber grommet on top of the **CRUISE MODULE** (See **Page 7**) before mounting the **GlobalCruise**. **Figure 3**

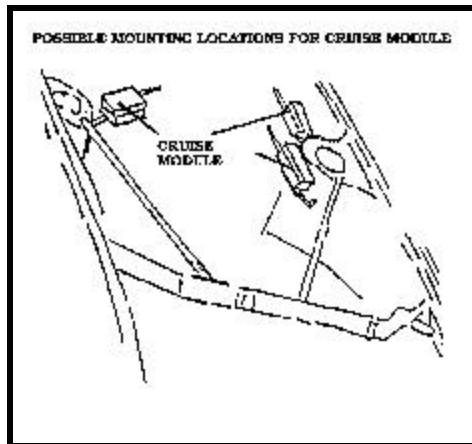

WARNING

Failure to follow the instruction manual could not only cause the **GlobalCruise** to work improperly, but could cause the throttle to hang up, possibly causing damage to your vehicle and injury and/or death to you and your passengers.

INSTALLATION

II. MEASURING THROTTLE CABLE TRAVEL

THIS IS A VERY IMPORTANT STEP. FAILURE TO DETERMINE THROTTLE CABLE TRAVEL COULD CAUSE DAMAGE TO YOUR VEHICLE AND/OR GlobalCruise.

MEASURE ONLY WITH THE ENGINE OFF. The **CRUISE CABLE** moves **41mm (1-5/8")**.

To measure throttle travel, measure the distance from Position "A" (Idle) to Position "B" (Wide Open Throttle).

- A. Make a mark on the throttle cable when the throttle is in the idle position. **Figure 4**
- B. Depress accelerator pedal and make a mark on the throttle cable when the throttle is in the wide open position. **Figure 5**

C. Measure the Distance "C" between the two marks. **Figure 6** If the distance is greater than **41mm (1-5/8")**, go to **Page 11**; If it is less, go to **Step D**.

- D. If the throttle travel is less than **41mm (1-5/8")**, you must add length to the **CRUISE CABLE** to provide slack.

NOTE: Slack is the distance the **CRUISE CABLE** moves before the throttle starts to move.

- E. Slide a **CONNECTOR COVER** on the throttle **LOOP CABLE** and on the **CRUISE CABLE**. Install a **BEAD CHAIN CONNECTOR** on the end of the **LOOP CABLE** and on the end of the **CRUISE CABLE**. The **BEAD CHAIN CONNECTOR** may need to be spread slightly for cable to enter.

- F. Install the end bead of the **BEAD CHAIN** in each **BEAD CHAIN CONNECTOR** with a bead (or beads) between them to add additional length. The beads inside the **BEAD CHAIN CONNECTORS** do not add length.

NOTE: Each bead of the **BEAD CHAIN** added between the **BEAD CHAIN CONNECTORS** will give you **7mm (.28")** of slack.

Example: If your throttle travels **35mm (1-3/8")**, you will need to add **one (1)** bead between connectors. **Figure 7**

- G. After the **BEAD CHAIN** is installed, lightly crimp the **BEAD CHAIN CONNECTORS** without pinching the cables and center the **CONNECTOR COVERS** over the **BEAD CHAIN CONNECTORS**.

NOTE: You must always use the **CONNECTOR COVERS**.

After determining your throttle cable travel, continue to **Section III**.

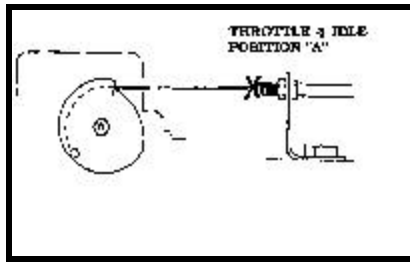

Figure 4

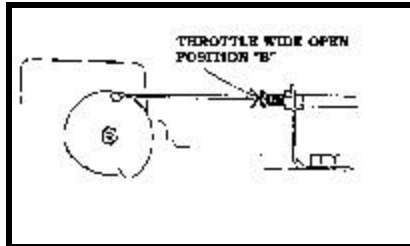

Figure 5

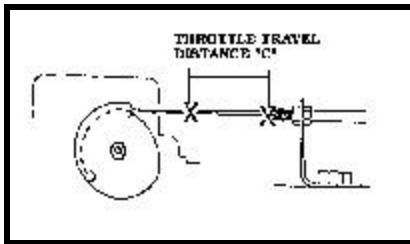

Figure 6

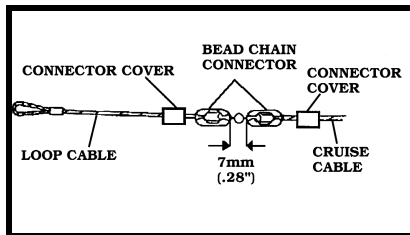

Figure 7

INSTALLATION

III. ATTACHING CRUISE CABLE TO THROTTLE

This section will cover the proper ways to use the hardware available. Each method contains sample illustrations showing how the connector is used in an actual installation. It must be noted, however, that you should have an understanding of how each attachment method works so that a proper installation is achieved.

There are **five (5)** different types of throttle connections.

- A. Pulley Assembly Using The **LOOP CABLE**
- B. Pulley Assembly Using **T-BAR ADAPTOR**
(See **Page 7**)
- C. Pedal Attachment.
- D. **Ford™** Throttle
- E. **General Motors™** and **Chrysler™** Throttle
Using **THREE BEAD CONNECTOR**

A. Pulley Assembly Using The **LOOP CABLE**

1. On some vehicles it may be necessary to remove the air cleaner to access the throttle pulley segment.
2. Set the pulley segment in an **OPEN** throttle position, and remove the throttle cable from the pulley.
3. Hold the **LOOP CABLE** between the holes in each side of the pulley. Slide the barrel at the end of the throttle cable through the slotted hole, then through the **LOOP CABLE** and into the second hole. **Figure 9**
4. Connect the **LOOP CABLE** to the **CRUISE CABLE** using the **BEAD CHAIN CONNECTOR** as follows:

Slide a **CONNECTOR COVER** on the **LOOP CABLE**. Install a **BEAD CHAIN CONNECTOR** onto the **LOOP CABLE** and then onto the **CRUISE CABLE**. **BEAD CHAIN CONNECTOR** may need to be spread slightly for cables to enter. After the **BEAD CHAIN CONNECTOR** is installed, lightly crimp the connector without pinching the cables. Then slide the **CONNECTOR COVER** over the center of the **BEAD CHAIN CONNECTOR**.

5. To secure the **LOOP CABLE** to the throttle cable, punch a small hole in the **CONNECTOR COVER** and slide the **TIE STRAP (102MM)** through the hole and secure to the throttle cable. **Figure 10**

NOTE: Firmly tighten the **TIE STRAP (102MM)** and remove excess to prevent possible throttle interference.

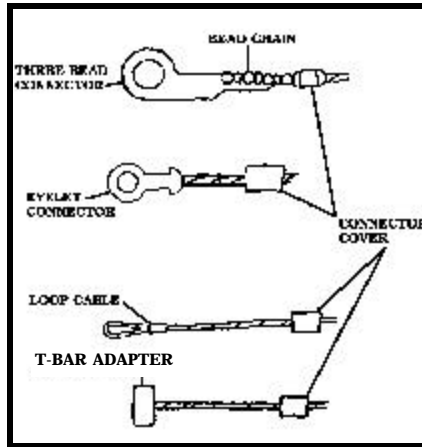

Figure 8

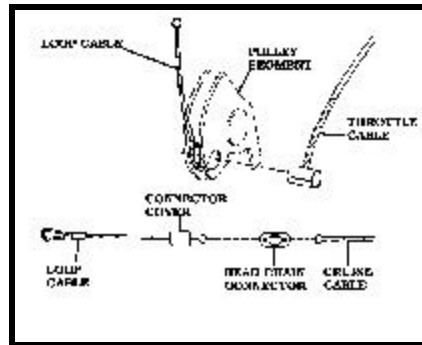

Figure 9

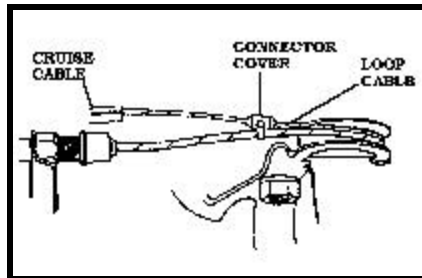

Figure 10

WARNING

If the **LOOP CABLE** is not secured to the existing throttle cable, it could come out of the pulley segment possibly causing the throttle to be held in a partially open position.

INSTALLATION

III. ATTACHING CRUISE CABLE TO THROTTLE (Continued)

B. Pulley Assembly (Dual) Using The T-BAR ADAPTOR

1. Remove air cleaner to expose the dual pulley segments.
2. Find the blank anchor that is located above the throttle anchor. Follow the instructions for anchoring the **CRUISE CABLE**. See **Page 15**.
3. Attach a **BEAD CHAIN CONNECTOR** onto the **CRUISE CABLE**. **Figure 11**
4. Attach the **T-BAR ADAPTOR** to the top pulley segment. Slide the **CONNECTOR COVER** onto the **T-BAR ADAPTOR**.
5. Attach the **T-BAR ADAPTOR** to the **BEAD CHAIN CONNECTOR**. Make sure to slide the **CONNECTOR COVER** over the **BEAD CHAIN CONNECTOR**. **Figure 12**

C. Pedal Attachment

1. Select a **TUBE CLAMP** that fits around the top of the accelerator pedal shaft. Make sure the tabs of the **TUBE CLAMP** point away from the bulkhead.
2. Attach the **BEAD CHAIN** to the **CRUISE CABLE** with a **BEAD CHAIN CONNECTOR**. Make sure to use a **CONNECTOR COVER**.
3. After you determine the length of **BEAD CHAIN** needed to attach to the accelerator pedal shaft, cut **BEAD CHAIN** and attach to the **EYELET CONNECTOR**. Make sure to use a **CONNECTOR COVER**.
4. Put **M5 BOLT** through the holes in the **TUBE CLAMP**. Slide the **EYELET CONNECTOR** over the bolt. Thread **LOCKNUT** onto the bolt and tighten. **Figure 13**

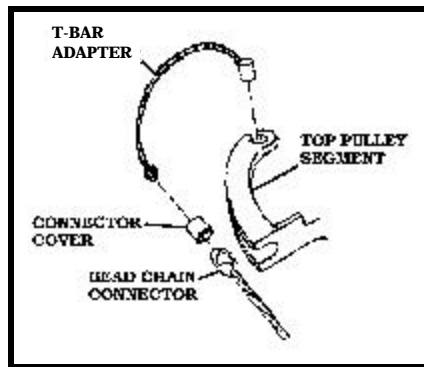

Figure 11

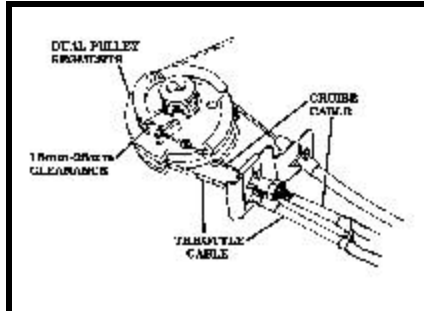

Figure 12

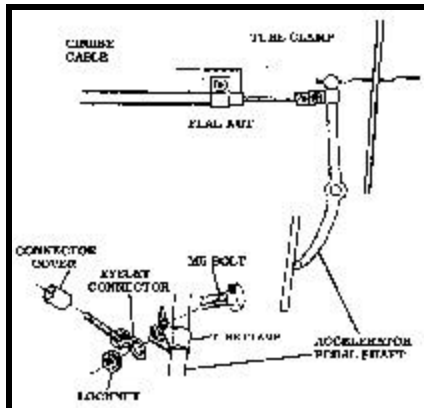

Figure 13

WARNING

Failure to follow the instruction manual could not only cause the **GlobalCruise** to work improperly, but could cause the throttle to hang up, possibly causing damage to your vehicle and injury and/or death to you and your passengers.

INSTALLATION

III. ATTACHING CRUISE CABLE TO THROTTLE (Continued)

D. Ford™ Throttle

1. Select a **TUBE CLAMP** that fits the throttle cable. Make sure the tabs of the **TUBE CLAMP** point away from the carburetor or air throttle, this will prevent the throttle from hanging. **Figure 14**
2. Attach **CRUISE CABLE** to the **EYELET CONNECTOR**.

NOTE: Use the **CONNECTOR COVER**.

3. Put the **M5 BOLT** through the holes in the **TUBE CLAMP**. Slide the **EYELET CONNECTOR** over the bolt. Thread the **LOCKNUT** onto the bolt and tighten. **Figure 14**
4. **Figure 15** is an example of a **Ford™** Throttle connection using the **TUBE CLAMP**.

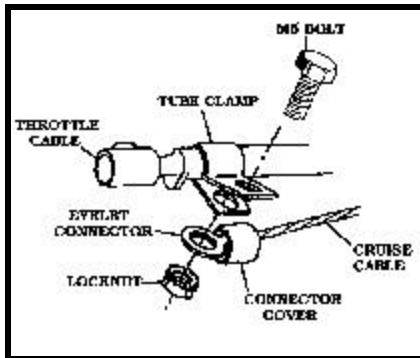

Figure 14

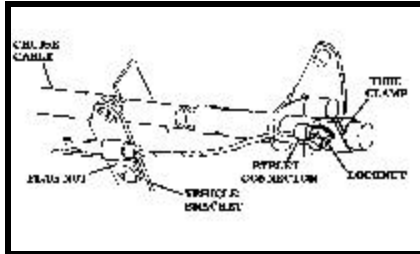

Figure 15

E. General Motors™ and Chrysler™ Throttle using THREE BEAD CONNECTOR.

1. Most **General Motors™** vehicles and many **Chrysler™** vehicles can use the **THREE BEAD CONNECTOR** to attach the **CRUISE CABLE**. **Figure 16**

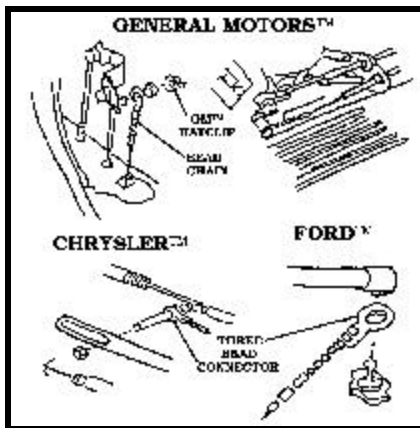

Figure 16

WARNING

Failure to follow the instruction manual could not only cause the **GlobalCruise** to work improperly, but could cause the throttle to hang up, possibly causing damage to your vehicle and injury and/or death to you and your passengers.

INSTALLATION

III. ATTACHING CRUISE CABLE TO THROTTLE (Continued)

E. General Motors™ and Chrysler™ Throttle using **THREE BEAD CONNECTOR**. (Continued)

2. Attach the **BEAD CHAIN** to the **THREE BEAD CONNECTOR**. Secure beads by folding the metal tabs. **Figure 17**
3. Remove clip or pin which retains throttle cable (and washer if provided) and install **THREE BEAD CONNECTOR** on the same side of throttle cable that the **CRUISE CABLE** will be anchored (this is necessary so that **CRUISE CABLE** and throttle cable will not cross).
4. The **THREE BEAD CONNECTOR** may need to be bent so that it clears the throttle cable. **Figure 18** Use the **TIE STRAP (102mm)** to hold the **THREE BEAD CONNECTOR** to the sleeve of the throttle cable. **Figure 18**

F. General Motors™, Ford™ and Chrysler™ Throttle using **STUD-CLIP W CABLE**.

1. Some **General Motors™, Ford™ and Chrysler™** vehicles have an attachment stud on the throttle pulley.
2. Slide a **BEAD CHAIN CONNECTOR COVER** over the **CRUISE CABLE**, then attach the **BEAD CHAIN CONNECTOR** to the cable. Attach the **STUD-CLIP W CABLE** to the **BEAD CHAIN CONNECTOR** and slide the **CONNECTOR COVER** over the **BEAD CHAIN CONNECTOR**. **Figure 19**
3. Slide the **STUD-CLIP W CABLE** over the throttle pulley attachment stud. Push the **STUD-CLIP** onto the vehicle stud until it snaps firmly onto the stud.

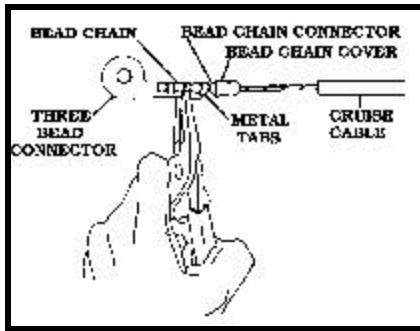

Figure 17

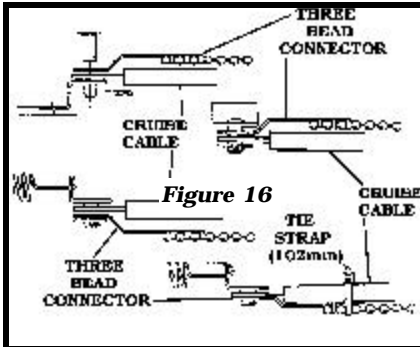

Figure 18

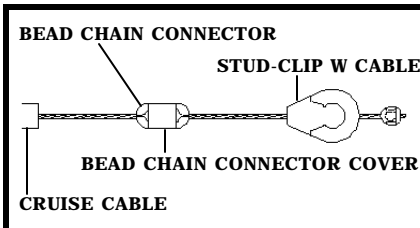

Figure 19

NOTE

After the **CRUISE CABLE** has been attached, manually move the throttle to assure the **CRUISE CABLE** does not hang up on any part of the vehicle.

WARNING

Failure to follow the instruction manual could not only cause the **GlobalCruise** to work improperly, but could cause the throttle to hang up, possibly causing damage to your vehicle and injury and/or death to you and your passengers.

INSTALLATION

IV. ANCHORING CRUISE CABLE

There are **three (3)** types of connectors used to anchor the **CRUISE CABLE**:

- A. **SNAP-IN ADAPTOR**
- B. **General Motors™** Blank Anchor
- C. **FLAG NUT**

A. SNAP-IN ADAPTOR

1. Before using the **SNAP-IN ADAPTOR**, remove the Adjustable Sleeve from the **CRUISE CABLE**. To use the **SNAP-IN ADAPTOR**, it will be necessary to form threads on the end of the **CRUISE CABLE**. This is easily accomplished by placing the **LOCKWASHER NUT** on the end of the **CRUISE CABLE** with your fingers. Then using an **11mm** box end wrench and turning clockwise until the desired amount of threads have been formed.

Figure 20

2. After the threads have been formed, screw the **SNAP-IN ADAPTOR** onto the **CRUISE CABLE**. **Figure 21**

NOTE

Insulation on the **CRUISE CABLE** must extend past the end of the **SNAP-IN ADAPTOR** on all applications.

3. The **SNAP-IN ADAPTOR** snaps into the square hole of the **CABLE BRACKET** **Figure 22** or snaps into an existing square hole in the vehicle (common on **GM™** vehicles). **Figure 23**

B. General Motors™ Blank Anchor

1. To locate the blank anchor on **General Motors™** vehicles, it is necessary to remove the air cleaner. The blank anchor is located above the throttle anchor.
2. This anchor is hollow except at one end. Use a **6.4mm (.25")** bit drill as shown in **Figure 24**.
3. Before using the **LOCKWASHER NUT**, remove the Adjustable sleeve from the **CRUISE CABLE**. Then use the **LOCKWASHER NUT** to form threads on the end of the **CRUISE CABLE**. This is easily accomplished by placing the **LOCKWASHER NUT** on the end of the **CRUISE CABLE** with your fingers. Then use an **11mm** box end wrench and turn clockwise until the desired amount of threads have been formed **Figure 20**.

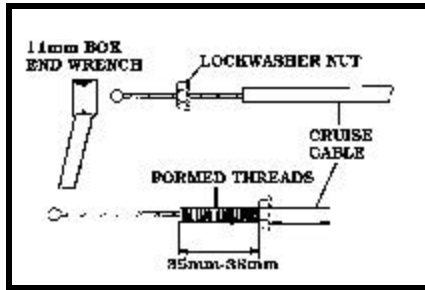

Figure 20

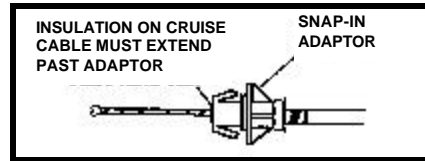

Figure 21

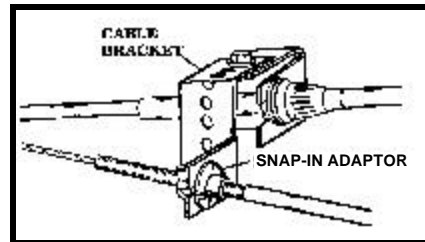

Figure 22

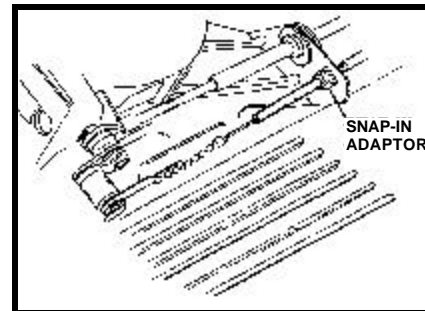

Figure 23

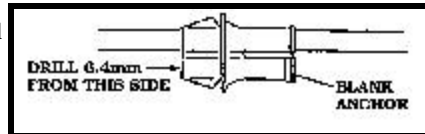

Figure 24

INSTALLATION

IV. ANCHORING CRUISE CABLE (CONTINUED)

B. General Motors™ Blank Anchor

4. Insert the **CRUISE CABLE** through the blank anchor and thread the other **LOCKWASHER NUT** in place. **Figure 25**

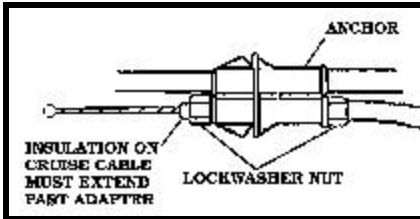

Figure 25

NOTE

If you do not use the other **LOCKWASHER NUT**, install a **TUBE CLAMP 152mm-178mm** from the anchor point. **Figure 26** This will keep the **CRUISE CABLE** from backing out of the anchor.

5. The **LOCKWASHER NUT** can also be used if there is a pre-existing **6.4mm** hole in a bracket on the vehicle or if it is possible to drill a **6.4mm** hole in a bracket on the vehicle.

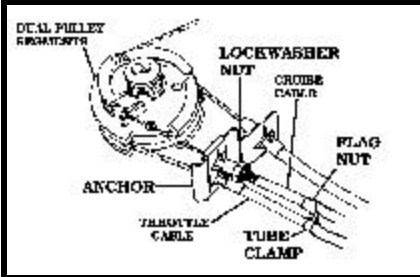

Figure 26

CAUTION

When using the **FLAG NUT** on the **CRUISE CABLE** the Adjustable Sleeve **MUST** be **REMOVED**.

When using a **TUBE CLAMP** on the **CRUISE CABLE** the adjustable sleeve **MUST** be **USED** to prevent slippage or binding of cable.

C. FLAG NUT

1. Before using the **FLAG NUT**, it will be necessary to form threads on the end of the **CRUISE CABLE**. This is easily accomplished by placing the **LOCKWASHER NUT** on the end of the **CRUISE CABLE** with your fingers. Then use an **11mm** box end wrench and turn clockwise until the desired amount of threads have been formed. **Figure 20, Page 15**
2. After the threads have been formed, screw the **FLAG NUT** onto the **CRUISE CABLE**. **Figure 28**
3. The **FLAG NUT** may be used to anchor the **CRUISE CABLE** to the existing throttle cable bracket. **Figure 29** In some cases there is an existing hole, in other cases you can drill a **5mm (.20")** hole in the bracket.
4. The **FLAG NUT** may also be used to anchor the **CRUISE CABLE** using the **CABLE BRACKET**. **Figure 30**

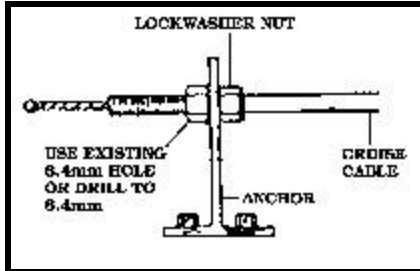

Figure 27

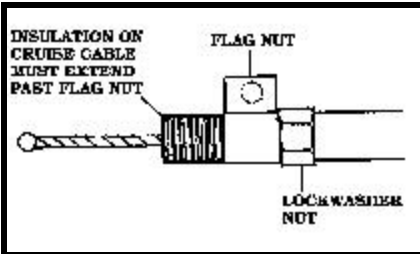

Figure 28

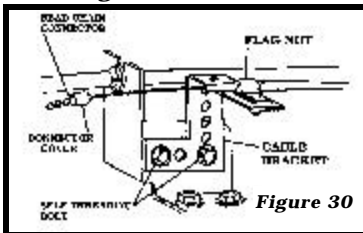

Figure 30

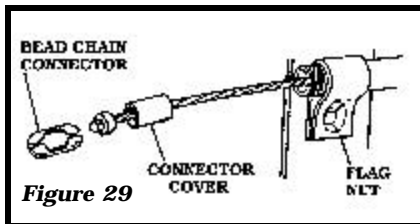

Figure 29

INSTALLATION

V. CRUISE HARNESS

A. Push Rubber Grommet securely into place on the cover of the **CRUISE MODULE**.

Figure 31

B. Straighten the **CRUISE HARNESS** and find the **2- & 4-pin** mating connectors. Separate the **2- & 4-pin** connectors. A small screwdriver may be needed (See **K** in **Figure 34**).

C. **CRUISE HARNESS** needs a **19mm (.75")** hole to pass through bulkhead. You may find one nearby, such as the speedometer cable hole or a small one you can file larger. If you find the right size hole in the right place, remove vehicle grommet. If not, drill, saw, or punch a **19mm** hole in bulkhead. A hole a few millimeters to the left or slightly higher than the steering column is usually a good place. **Figure 32**

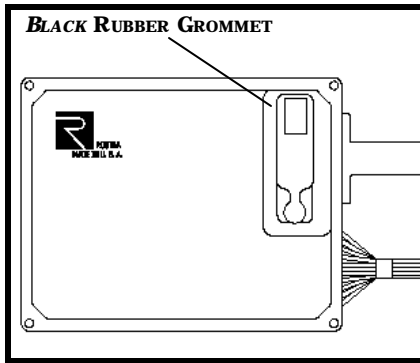

Figure 31

NOTE

Check inside before drilling, sawing, or filing so you don't damage anything.

D. From engine side, pass the **2- & 4-pin** connectors through hole. If you do not hook up the **Dark Blue TACH** wire and the **Gray VSS** wire under the hood, pass them through to the inside of the vehicle, also.

E. Reattach the **2- & 4-pin** mating connectors and make the necessary wire connections. (See **Page 18** for wiring instructions)

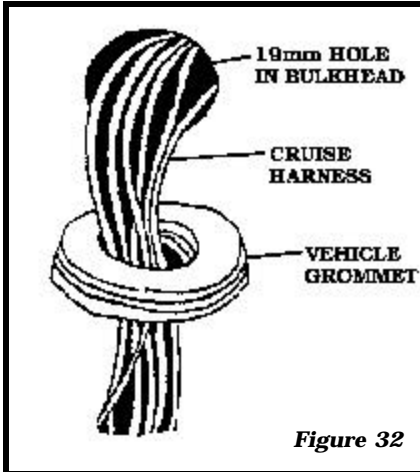

Figure 32

VI. SEALING BULKHEAD

Seal hole in bulkhead with **SEALING PUTTY** as shown in **Figure 32**.

VII. CONTROL SWITCH INSTALLATION

If your cruise control switch is the type which clamps on the turn signal lever, requires cutting the turn signal lever, or is mounted on the instrument panel, follow the instructions packaged with it. If you have a switch which replaces the complete original equipment turn signal lever, remove the existing lever and install the cruise control switch and lever assembly as instructed in the vehicle shop service manual.

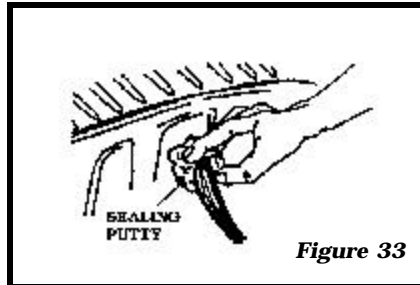

Figure 33

WARNING

Failure to follow the instruction manual could not only cause the **GlobalCruise** to work improperly, but could cause the throttle to hang up, possibly causing damage to your vehicle and injury and/or death to you and your passengers.

INSTALLATION

VIII. WIRING ATTACHMENTS TO VEHICLE

Utilize **Figure 34** to make the necessary wiring harness connections to your vehicle.

CAUTION

Before making any wiring connections, be sure to disconnect your vehicle's negative battery cable to avoid electrical shock and/or damage to the vehicle's electrical system.

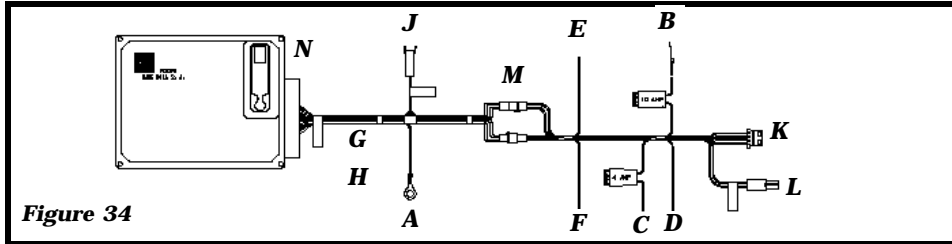

Figure 34

A. Black Ground Wire

In order to find a good ground for the cruise system, find a vehicle ground point which is a clean unpainted metal surface. If the cruise control does not "see" ground at all times, it will not function.

NOTE: Do not use the engine as a grounding point. Do not use the cable bracket as a grounding point.

NOTE: To find a place to get electrical power you will need to ground one lead of your test light or volt-ohmmeter. Find electrical ground by turning **ON** the ignition switch and touching one lead to a "Hot" fused terminal at fuse panel; touch other lead to unpainted metal part of vehicle. The metal you touch, if it makes continuity, is ground. The bracket for the parking brake lever is usually a good ground. Turn the ignition **OFF**.

B. Brown Accessory Power

Find a fuse at the fuse panel that supplies power to one of the vehicles accessories. It should be +12 volts when the key is **ON** and **zero (0)** volts when the key is **OFF** or in the **START (CRANK)** position.

C. Red Brake Positive

"Hot" side of brake switch: Use the wire at the brake switch connector with constant +12 volts

D. Violet Brake Negative

"Cold" side of brake switch: Use the wire at the brake switch connector with **zero (0)** resistance when brake is not pressed, and +12 volts or open resistance when brake is pressed.

E. Dark Blue Tachometer (TACH) Wire

The **TACH** function is a safety feature of the **GlobalCruise**.

If a vehicle with an automatic transmission is accidentally "knocked" into neutral while the vehicle is in motion and the **GlobalCruise** is active, the **TACH** wire, when connected, will disengage the **GlobalCruise** before engine over-rev. If the **TACH** wire is not "hooked-up", the cruise control will function; however the **TACH** over-rev safety feature will be inactive; this is dangerous and not recommended. **ROSTRA PRECISION CONTROLS, INC.** always recommends the attachment of the **TACH** wire.

On a vehicle with a manual transmission, the **TACH** wire connection is not required only when **CLUTCH DISENGAGEMENT SWITCH (Kit# 250-4206)** has been installed; this will take into account the **TACH** over-rev safety feature. The **TACH** wire should be grounded when using a clutch disengagement switch to ensure that the wire does not introduce "trashy" signals into the system.

INSTALLATION

F. Gray Vehicle Speed Sensor (VSS) Wire

The **Gray Vehicle Speed Signal (VSS)** wire is how the **GlobalCruise** “knows” how fast the vehicle is moving. The **Pulses Per Mile/Kilometer (PPM/PPK)** are a characteristic of the vehicle and must be set accordingly (See **Page 7**). If **VSS** cannot be located on the vehicle then an auxiliary road speed sensor must be used [**Signal Generator** or **Magnet & Coil Pick-Up Kit (Kit# 250-4165)**]. If you use an auxiliary speed sensor, plug it into auxiliary speed sensor connector (**G** in **Figure 34**) and trim the **Gray VSS** wire as not to pick-up any stray signals.

In order to locate the **VSS** and **TACH** signals, consult a **Vehicle Shop Manual**, our **Vehicle Technical Guide (Rostra Form# 2482)**, try our **Fax-Back System** at **(910) 610-4191**, call our **Technical Service Department** at **(910) 277-1828**, **Fax** us at **(910) 276-3759 (USA)** or visit us on the web at **www.rostra.com**.

G. Light Green Neutral Safety (NSS)

The **NSS** function is a safety feature of the **GlobalCruise**.

If a vehicle with an automatic transmission is accidentally “knocked” into neutral while the vehicle is in motion and the **GlobalCruise** is active, the **NSS** wire, when connected, will disengage the **GlobalCruise** before engine over-rev. If the **NSS** wire is not “hooked-up”, the cruise control will function; however the engine over-rev protection will be inactive; this is dangerous and not recommended. This wire terminates in the harness.

H. Orange Enable Output (ENO) Wire

The **ENO Function** allows you to use the **GlobalCruise** as a driver for an external wheatlamp connected to a V+. The **ENO** Wire will drive low when the system is engaged and to a high impedance state otherwise. This wire terminates in the harness.

J. Auxiliary Speed Sensor Connector

This connector is utilized when the **Gray VSS** wire is not used as the vehicle speed source. Both **Rostra [Signal Generator and Magnet & Coil Pick-Up Kit (Kit# 250-4165)]** have a mating connector which plugs right into the wiring harness.

K. 4-Pin Switch Connector

This connector is utilized by the control switch. All **Rostra** control switches contain a mating connector which plugs right into the main wiring harness.

L. 2-Pin Switch Connector

This connector is used in conjunction with the **4-Pin Switch Connector (H** in **Figure 34)**. The **2-Pin Switch Connector (J** in **Figure 34)** is utilized by control switches which require an additional power and ground source such as those containing an **LED** indicator light or **rostra Radio Frequency (RF)** models.

M. Bulkhead Connectors

These connectors simplify the installation of the wiring harness through the engine bulkhead (*firewall*). Simply disconnect the connectors, run them through any **19mm (.75”)** hole in the firewall (*preferably near the steering column*), and reconnect them once inside the passenger compartment.

N. GlobalCruise Servo Connector

TROUBLESHOOTING

IX. SELF DIAGNOSTIC TESTING PROCEDURE

The **GlobalCruise** is equipped with a **Amber Self Diagnostic Surface Mount Light Emitting Diode (LED)** located underneath the rubber grommet on top of the **CRUISE MODULE**. Utilize the following **Self Diagnostic Procedure** to troubleshoot your cruise control if it does not function properly once installed.

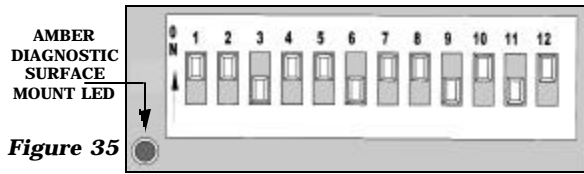

Figure 35

The twelve (12) programming switches and diagnostic LED are located under the rubber grommet on top of the CRUISE MODULE.

Carefully follow the procedures below to enter your cruise control into **Self Diagnostic Mode**.

- Step 1:** Turn the cruise control switch **OFF**.
Step 2: Turn the ignition to the **OFF** position.
Step 3 Closed Circuit Control Switch (See **Page 22**): Press and hold the **RESUME/ACCEL** button while you turn the ignition switch to the **ON** position without starting the engine. Now release the the **RESUME/ACCEL** slide switch.

Open Circuit Control Switch (See **Page 22**): Turn the ignition switch to the **ON** position without starting the engine, hold the **RESUME/ACCEL** button down while you turn the cruise control switch to the **ON** position.

- Step 4:** The **Diagnostic LED** should be **OFF** at this time. You are now in **Self Diagnostic Mode**.

Continue to follow the procedures below to test your cruise control switch, brake switch connections and **VSS** signal.

- Step 5:** Press and Release the **SET/COAST** button. The **LED** should light each time the button is pressed and go out when it is released. If so, continue to **Step 6**; if not, go to **Step 5a**.
a. Check steps to entering **Diagnostic Mode** and test again.
b. Check **Programming Switch# 12**. It should be **ON** for a **Normally Closed Circuit Control Switch** and **OFF** for a **Normally Open Circuit Control Switch**. (See **Page 22**): If set incorrectly, reset and reenter **Diagnostic Mode**.
c. Check power to the **CRUISE MODULE** if none of the diagnostic commands are functioning.
d. Check Cruise Control Switch (See **Page 22**).
- Step 6:** Press and release the **RESUME/ACCEL** button. The **LED** should light each time the button is pressed and go out when it is released. If so, continue to **Step 7**; if not, go to **Step 6a**.
a. Check steps to entering **Diagnostic Mode** and test again.
b. Check power to the **CRUISE MODULE** if none of the diagnostic commands are functioning.
c. Check Cruise Control Switch (See **Page 22**).
- Step 7:** You will need a second person to help you perform this test. Press and release the **Brake Pedal**. The **LED** should light each time the brake is pressed and go out when it is released. If so, continue to **Step 8**; if not, go to **Step 7a**.
a. Check steps to entering **Diagnostic Mode** and test again.
b. Check power to the **Red Brake Positive** wire.
c. Check power to the **CRUISE MODULE** if none of the diagnostic commands are functioning.
d. Check Brake Switch Connector and wiring to brake switch.
- Step 8:**
- Vehicle's own computer as **VSS** source: Roll the vehicle at least **two (2)** meters forward or backward, the **LED** should flash and continue to flash at the same rate. If so, continue to **Step 9**; if not, go to **Step 8ai**.
 - Check steps to entering **Diagnostic Mode** and test again.
 - Check **Programming Switch# 10**. It should be **ON** for **Square Wave Input**. If set incorrectly, reset and reenter **Diagnostic Mode**.
 - Some vehicles need to be pushed more than **two (2)** meters. In that case, raise **one (1)** of the vehicle drive wheels (*both drive wheels on a limited slip differential*) and block the non drive wheels. Use a support stand for safety. Spin the drive wheel by hand as fast as possible. The **LED** should flash and continue to flash at the same rate. If so, continue to **Step 9**; if not, go to **Step 8aiv**.
 - Either your **VSS** wire is incorrect or your connection is bad. Inspect your **VSS** connection and reenter **Self Diagnostic Mode**.

TROUBLESHOOTING

- b. **Auxiliary Speed Sensor** (*SIGNAL GENERATOR or MAGNET & COIL PICK-UP KIT (Kit# 250-4165)*) Raise **one (1)** of the vehicle drive wheels (*both drive wheels on a limited slip differential*) and block the non drive wheels. Use a support stand for safety. Spin the drive wheel by hand as fast as possible (*You must spin the wheel at least 4.8 KPH (3 MPH) or faster in order to test an auxiliary speed signal.*) The **LED** should flash and continue to flash at the same rate. If so, continue to **Step 9**; if not, go to **Step 8bi**.
- i. Check steps to entering **Diagnostic Mode** and test again.
 - ii. Check **Programming Switch# 10**. It should be **OFF** for **Sine Wave Input**. If set incorrectly, reset and reenter **Diagnostic Mode**.

Step 9: Your **WorldCruise 2** has successfully passed the **Self Diagnostic Testing Procedure**. If it still does not function, test your **TACH** signal.

X. TACH SIGNAL TESTING PROCEDURE

Step 1: Turn the cruise control switch **OFF**.

Step 2: Turn the ignition to the **OFF** position.

Step 3: Closed Circuit Control Switch (See **Page 22**): Press and hold the **RESUME/ACCEL** button while you turn the ignition switch to the **ON** position and **start the engine**. Now release the the **RESUME/ACCEL** slide switch.

Open Circuit Control Switch (See **Page 22**): Turn the ignition switch to the **ON** position and **start the engine**, hold the **RESUME/ACCEL** button down while you turn the cruise control switch to the **ON** position.

Step 4: The **Diagnostic LED** should be flashing. Rev the engine, the **LED** should flash faster at higher RPM's. If so, your **TACH** signal is valid, if not, go to **Step 4a**.

- a. Check steps to entering **Diagnostic Mode** and test again.
- b. Either your **TACH** wire is incorrect or your connection is bad. Inspect your **TACH** connection and reenter **Self Diagnostic Mode**.

General Wiring Diagram GlobalCruise System

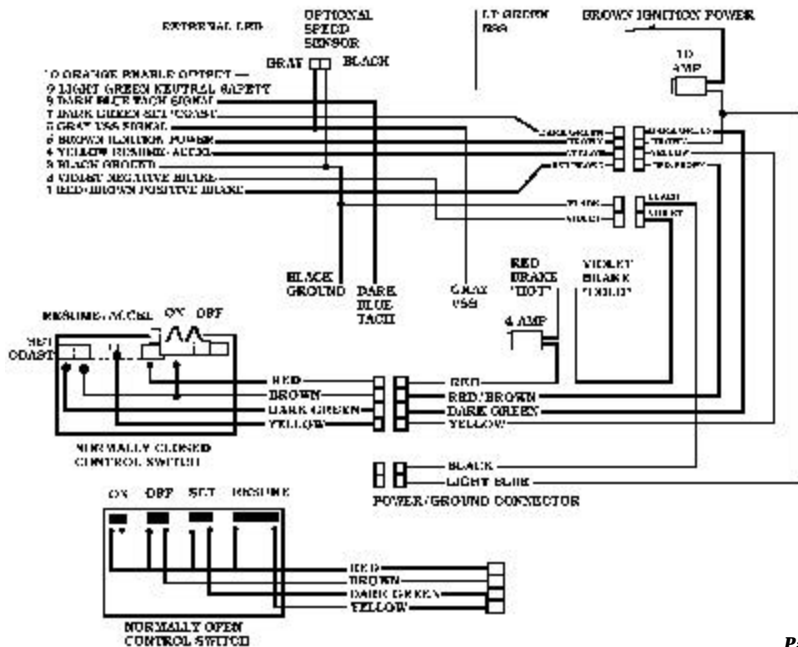

TROUBLESHOOTING

XI. CONTROL SWITCH TESTING PROCEDURE

Utilize the following continuity charts to test your control switch if you suspect that it is not functioning properly. You need to unplug the 8-pin connector from the **CRUISE MODULE** to perform these tests.

1. Ground the test light lead and verify that the light works by probing a known power source.
2. Follow the test charts below using the appropriate chart for your control switch.

Your control switch is a **Closed Circuit Control Switch** if:

1. Its **ROSTRA** part number is **250-3002, 250-3018, 250-3020, 250-3021, 250-3026, 250-3032, 250-3084, 250-3091, 250-3100, 250-3120, 250-3125, 250-3126, 250-3127, 250-3133, 250-3167, 250-3168, 250-3169, 250-3175, 250-3180, 250-3194, 250-3304, 250-3328, 250-3421, 250-3446**

OR

2. You must push the control button to the **left** for the **RESUME/ACCEL** function.

Your control switch is an **Open Circuit Control Switch** if:

1. Its **ROSTRA** part number is **250-3357, 250-3358, 250-3443, 250-3444, 250-3592, 250-3593, 250-3632, 250-3633, 250-3594, 250-3595, 250-3742, 250-3743.**

OR

2. You must push the control button to the **right** for the **RESUME/ACCEL** function.

OR

3. It has a **Green LED Indicator Light**.

OR

4. It is a **ROSTRA Radio Frequency (RF)** control switch.

CLOSED CIRCUIT CONTROL SWITCH

IGNITION SWITCH POSITION	CONTROL SWITCH POSITION	RED WIRE	BLACK GREEN WIRE	YELLOW WIRE	BROWN WIRE
OFF	OFF	ON	OFF	OFF	OFF
OFF	ON	ON	ON	OFF	ON
OFF	ON press and hold RESUME/ACCEL	ON	OFF	ON	ON
OFF	ON press and hold RESUME/ACCEL	ON	ON	ON	ON
ON	ON	ON	ON	OFF	ON
CRANK or START	ON	ON	ON	OFF	ON

OPEN CIRCUIT CONTROL SWITCH

IGNITION SWITCH POSITION	CONTROL SWITCH POSITION	RED WIRE	BLACK GREEN WIRE	YELLOW WIRE	BROWN WIRE
OFF	OFF	ON	OFF	OFF	OFF
OFF	ON	ON	OFF	OFF	ON
OFF	ON press and hold RESUME/ACCEL	ON	ON	OFF	ON
OFF	ON press and hold RESUME/ACCEL	ON	OFF	ON	ON
ON	ON	ON	OFF	OFF	ON
CRANK or START	ON	ON	OFF	OFF	ON

The **CRANK** or **START IGNITION SWITCH POSITION** refers to the momentary state when the key starts the engine just before it returns to the **RUN IGNITION SWITCH POSITION**.

WARRANTY

The Manufacturer warrants to the original retail purchaser of the **GlobalCruise** that should this product or any part thereof, under normal use and conditions, be proven defective material or workmanship within **36** months or **36,000** miles of the original purchase, such defect(s) will be repaired or replaced (at **The Manufacturer's** option) without charge for the parts.

To obtain repair or replacement within the terms of this Warranty, the product is to be delivered with proof of warranty coverage (e.g. bill of sale), specification of defect(s), transportation prepaid to an approved warranty station

This **WARRANTY** does not cover the costs incurred for removal or reinstallation of the product, or damage to vehicle electrical systems.

This **WARRANTY** does not apply to any product or part thereof which in the opinion of **The Manufacturer** has been damaged through alteration, improper installation, mishandling, misuse, neglect or accident.

This **WARRANTY** is in lieu of all other express warranties or liabilities. **ANY IMPLIED WARRANTIES, INCLUDING ANY IMPLIED WARRANTY OF MERCHANTABILITY, SHALL BE LIMITED TO THE DURATION OF THIS WRITTEN WARRANTY. ANY ACTION FOR BREACH OF ANY WARRANTY HERE UNDER INCLUDING ANY IMPLIED WARRANTY OF MERCHANTABILITY MUST BE BROUGHT WITHIN A PERIOD OF 18 MONTHS FROM THE DATE OF ORIGINAL PURCHASE. IN NO CASE SHALL ROSTRA PRECISION CONTROLS, INC. BE LIABLE FOR ANY CONSEQUENTIAL OR INCIDENTAL DAMAGES FOR BREACH OF THIS OR ANY OTHER WARRANTY, EXPRESS OR IMPLIED, WHATSOEVER.** No person or representative is authorized to assume for the **Company** any liability other than expressed herein in connection with the sale of this product.

THE EXTENT OF THE COMPANY'S LIABILITY UNDER THIS WARRANTY IS LIMITED TO THE REPAIR OR REPLACEMENT PROVIDED ABOVE AND, IN NO EVENT, SHALL THE COMPANY'S LIABILITY EXCEED THE PURCHASE PRICE PAID BY THE PURCHASER OF THE PRODUCT.

Some states do not allow limitations on how long an implied warranty lasts or the exclusion or limitation of incidental or consequential damage so the above limitations or exclusions may not apply to you. This **WARRANTY** gives you specific legal rights and you may also have other rights which vary from state to state.

OWNER'S WARRANTY RECORD	
(To Be Completed by selling dealer and retained by customer)	
Customer Name	_____
Address	_____
City	_____ State _____ Zip _____
Dealer Name	_____
Dealer Address	_____
City	_____ State _____ Zip _____
Date Purchased	_____ Date Installed _____
Year/Make/Model Vehicle	_____
Mileage at time of Installation	_____

OPERATING INSTRUCTIONS

XII. GlobalCruise OPERATING INSTRUCTIONS

ON: To operate the **GlobalCruise**, turn the power button **ON**. (**Green LED Indicator** will light, if equipped.) Wait three (3) seconds before setting speed.

SET SPEED: To engage system, drive at any speed above **50 KPH (33 MPH)**, press **SET/COAST** or press **RESUME/ACCEL** and release, then remove your foot from the accelerator pedal. Automatic control will be at the speed of the vehicle when the button is released plus or minus **3 KPH (1-1/2 MPH)**. Press accelerator and speed will increase, release accelerator and you will return to set speed.

NOTE: The **RESUME/ACCEL** button will **SET** the **GlobalCruise** without pressing the **SET** button first.

COAST: Press and Hold the **SET/COAST** button and your speed will decrease. Release button and speed of vehicle at time button is released will be new set speed if above **50 KPH (33 MPH)**.

ACCEL: Press and hold the **RESUME/ACCEL** button and your speed will increase. Release button and you will have a new higher set speed.

TAP-UP: You can gradually increase your speed by quickly pressing and releasing the **RESUME/ACCEL** button. Each time you press and release the button your speed will increase by **1-1/2 to 5 KPH (2 to 3 MPH)**.

TAP-DOWN: You can gradually decrease your speed by quickly pressing and releasing the **SET/COAST** button. Each time you press and release the button your speed will decrease by **1-1/2 to 5 KPH (2 to 3 MPH)**.

DISENGAGE: Depress brake pedal slightly; automatic speed control will cease but set speed will stay in the system's memory. Also, you can disengage by pressing button to **OFF** position, but this erases the memory. To get the **RESUME** feature to work again, you must first set a speed. Turning **OFF** the ignition also clears the system's memory.

RESUME: After disengaging system with brake or clutch, return to **SET** speed by driving above **50 KPH (33 MPH)**. Then press **RESUME/ACCEL** button and release it. If acceleration rate is faster or slower than you like, drive to within a few **KPH (MPH)** of your set speed, then press and release the **RESUME/ACCEL** button.

THINGS YOU SHOULD KNOW ABOUT YOUR GlobalCruise

The performance of the **GlobalCruise** is dependent upon the condition of the engine, its size and even by the type of emission control equipment it has. Driving at higher altitudes will have an effect on **GlobalCruise** performance.

Under normal conditions and with proper switch settings, speed should be controlled within plus or minus **3 KPH (1-1/2 MPH)**. There may be situations; however, which make it seem as if the **GlobalCruise** is not capable of functioning accurately, such as an extra heavy load, a very steep hill, or a severe headwind.

CAUTION: Do not use the GlobalCruise on a slippery road nor in heavy traffic.

CAUTION: (Manual Transmission) While driving with the GlobalCruise ON, do not shift to neutral without depressing the clutch pedal, as this may cause engine racing or overrevving. If this happens, depress the clutch pedal or turn OFF the main Cruise Control Switch immediately.

OUR QUALIFIED EXPERT TECHNICAL SERVICE DEPARTMENT IS READY TO ASSIST YOU WITH ANY QUESTIONS OR PROBLEMS THAT YOU MAY HAVE ABOUT OUR PRODUCT. CONTACT US VIA PHONE AT (910) 277-1828 (USA) OR FAX AT (910) 276-3759 (USA).